

User Manual

JAXSUNNY

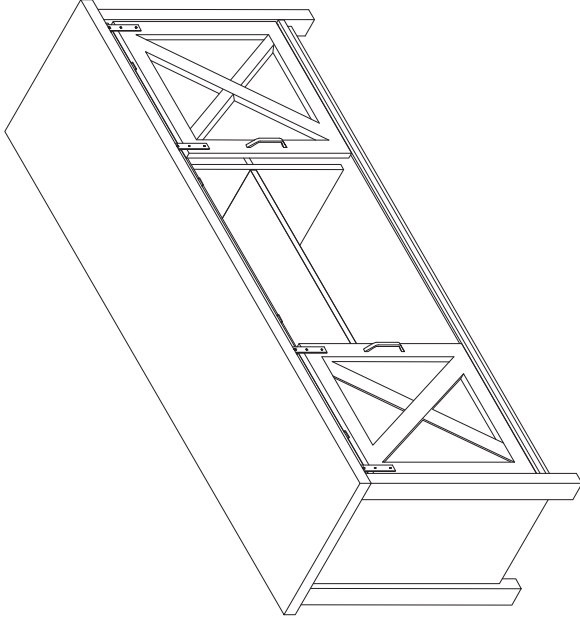

Model Number: HG61A0833
HG61E0925

JAXSUNNY

Dear Customer,

Thank you for your purchase. JAXSUNNY is committed to providing affordable high-quality furniture worldwide. Each piece is made with the respect for human and the environment. Thousands of families use JAXSUNNY products as a home fashion.

When you receive the product, please make sure that all the parts are intact. Then please browse the entire installation manual before assembly. If problems occur unsatisfactorily as follows:

- a. The outer box is damaged.**
- b. The product is damaged / bent / cracked while you open the box.**
- c. The parts / accessories / assembly tools are missing.**
- d. The product is hard to assemble.**
- e. The instructions are not clear and can not be referred to.**
- f. The product has functional problems.**
- g. Other aspects that you are not satisfied with.**

Please do not hesitate to contact us for help (Be sure to mark the **SKU NUMBER**, e.g., HG9150320, and the **TRACKING NUMBER**). Our JAXSUNNY team with factory direct after-sales service will reply within 24 hours and will do our best to resolve the problem for you. Our services are available at any time.

Sincerely,
JAXSUNNY Team



You need

1 Tools required
A Phillips head screwdriver is required for the assembly of this product. (not included)
Power tools should not be used to assemble this product.

2 1 person is needed



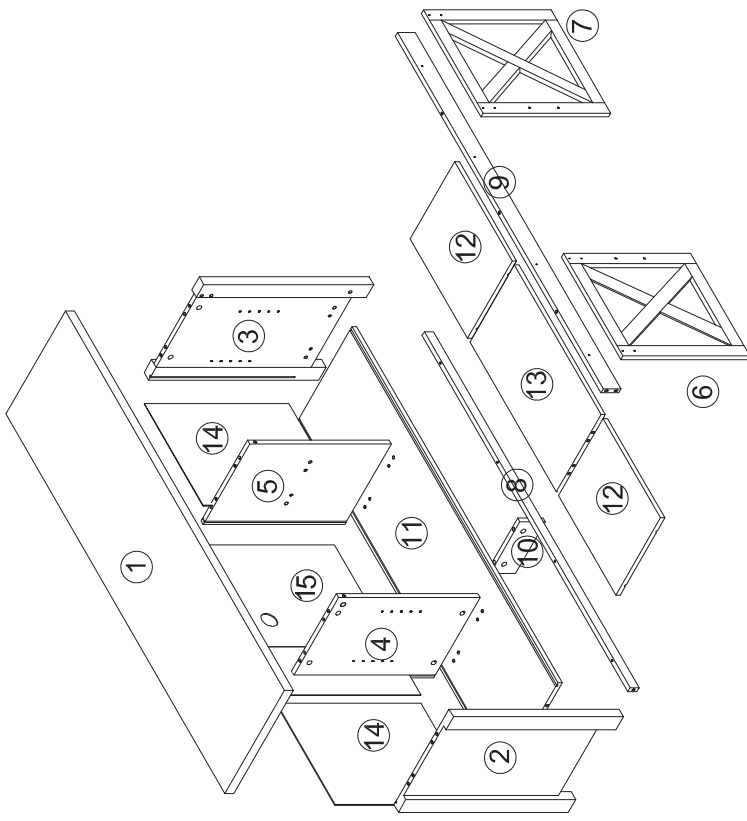

Technical Specifications	
Brand	JAXSUNNY
Material	MDF+METAL
Colour	Grey
Size	1470X400X605MM

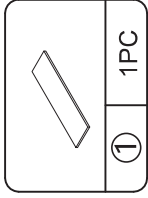
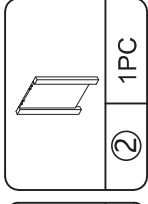
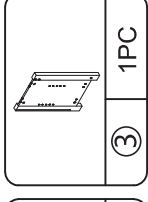
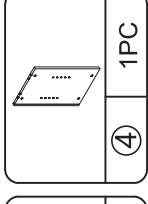
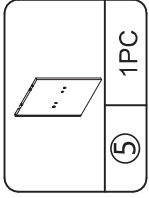
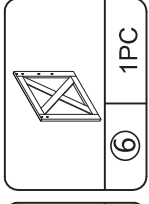
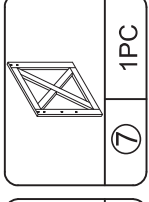
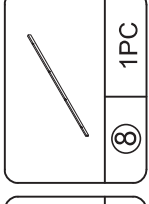
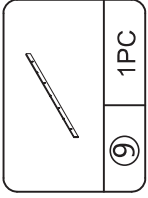
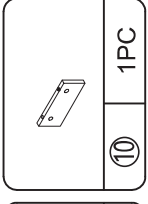
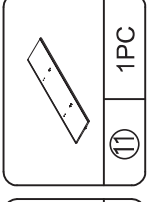
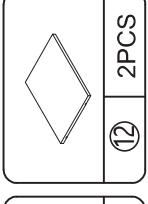
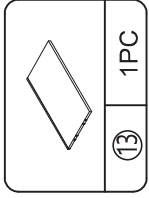
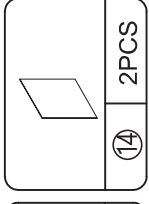
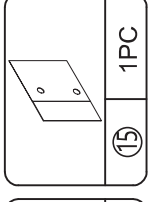
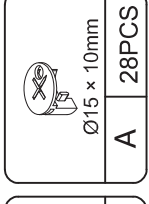
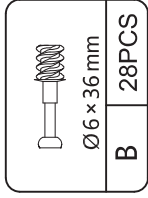
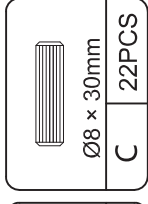
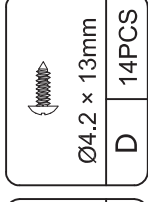
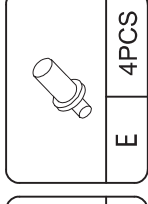
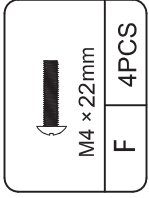

PRODUCT ASSEMBLY

PRODUCT ASSEMBLY

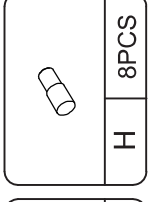
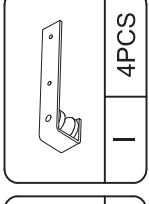
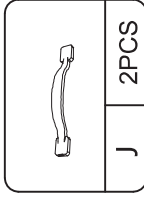
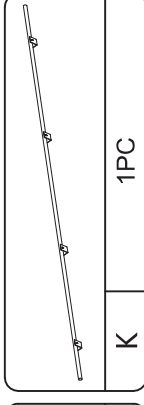
Hardware List

			
① 1PC	② 1PC	③ 1PC	④ 1PC
			
⑤ 1PC	⑥ 1PC	⑦ 1PC	⑧ 1PC
			
⑨ 1PC	⑩ 1PC	⑪ 1PC	⑫ 2PCS
			
⑬ 1PC	⑭ 2PCS	⑮ 1PC	A 28PCS
			
B 28PCS	C 22PCS	D 14PCS	E 4PCS
			
F 4PCS	G 4PCS	H 8PCS	I 4PCS
			
J 2PCS	K 1PC	13 1PC	

 Check the package contents before getting started !

STEP 1

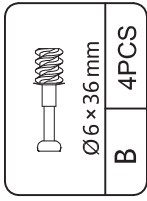
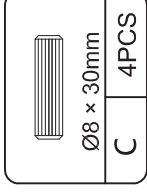
	
B 4PCS	C 4PCS

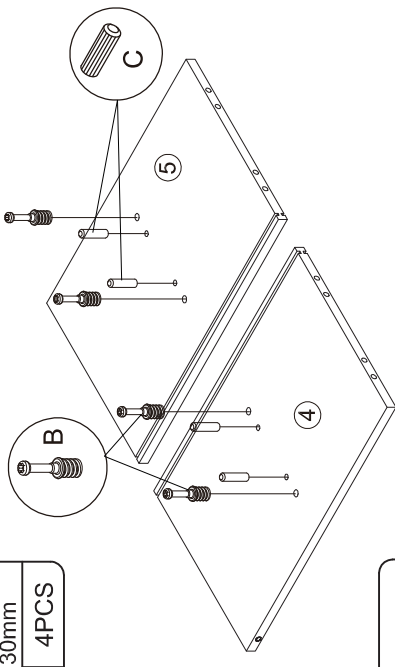

STEP 2

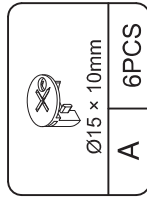
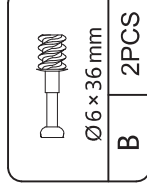
	
A 6PCS	B 2PCS

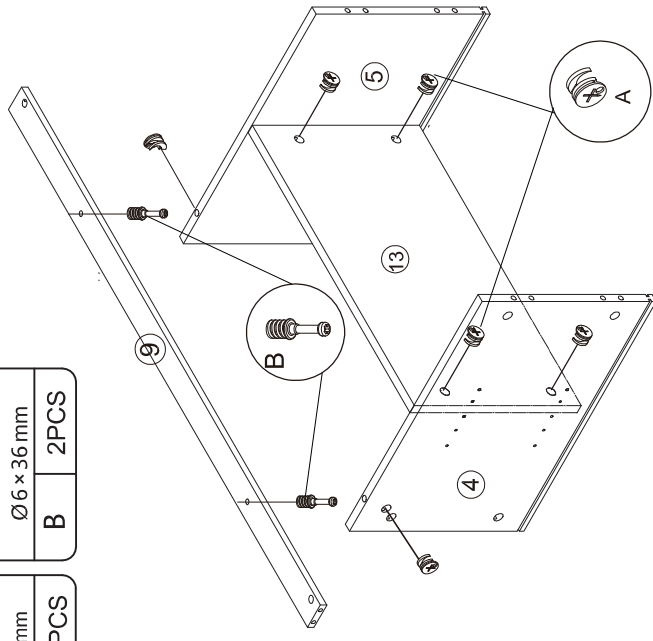

PRODUCT ASSEMBLY

STEP 3

	Ø15 x 10mm	A	2PCS
---	------------	---	------

	Ø6 x 36 mm	B	2PCS
---	------------	---	------

	Ø4.2 x 40mm	G	4PCS
---	-------------	---	------

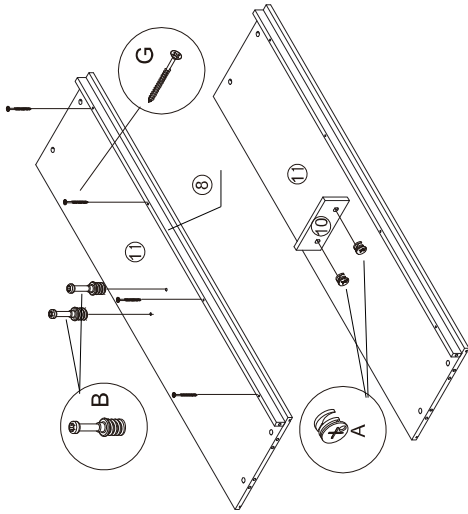

STEP 4

	Ø6 x 36 mm	B	4PCS
---	------------	---	------

	Ø8 x 30mm	C	4PCS
---	-----------	---	------

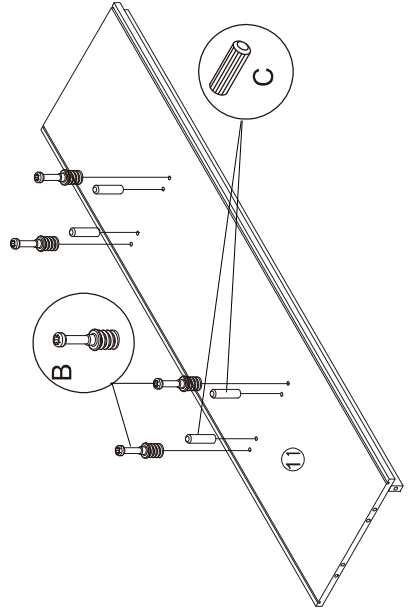

PRODUCT ASSEMBLY

STEP 5

	Ø15 x 10mm	A	4PCS
---	------------	---	------

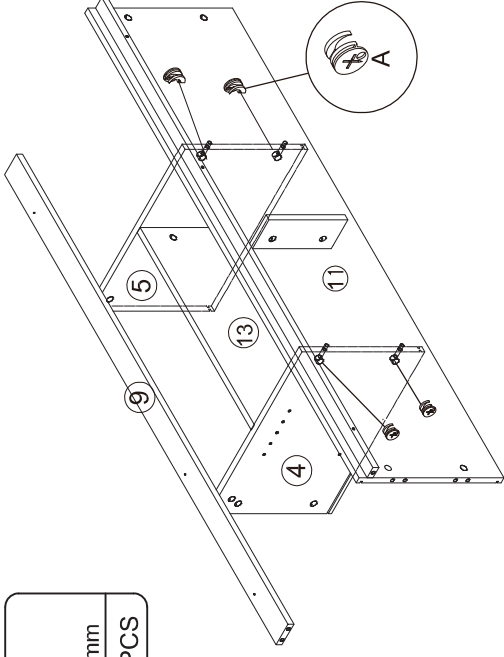

STEP 6

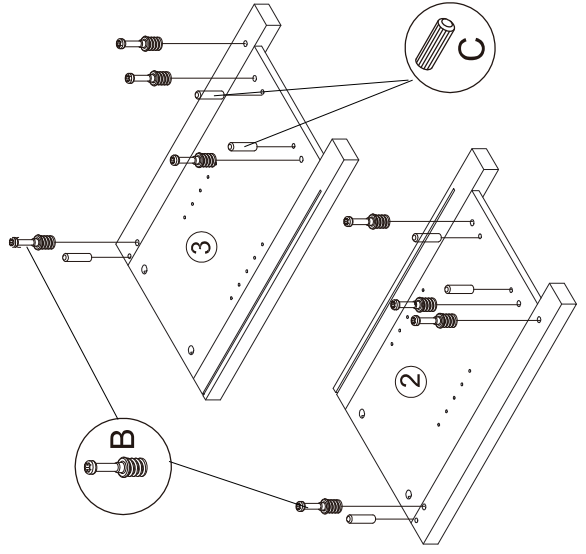

	Ø6 x 36 mm	B	8PCS
---	------------	---	------

	Ø8 x 30mm	C	6PCS
---	-----------	---	------



PRODUCT ASSEMBLY

STEP 7

	Ø15 x 10mm	A	8PCS
	Ø4.2 x 13mm	D	4PCS
		K	1PC

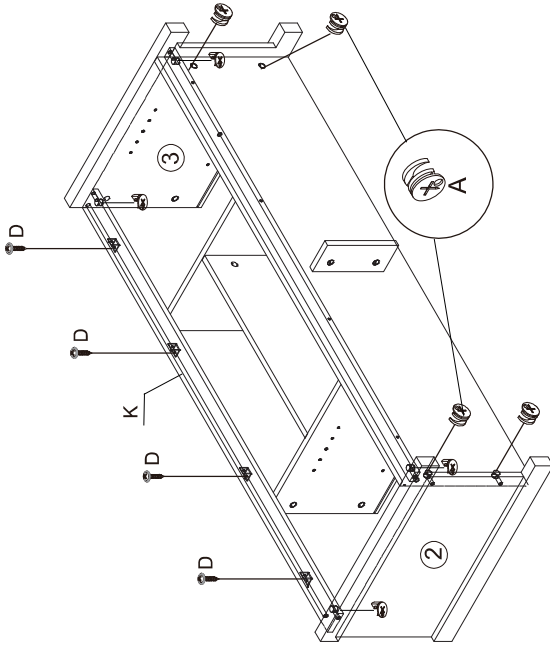

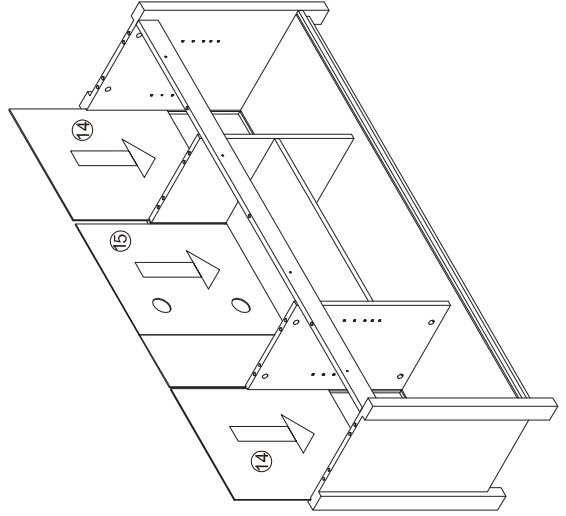

STEP 8



PRODUCT ASSEMBLY

STEP 9

	Ø6 x 36mm	B	8PCS
	Ø8 x 30mm	C	8PCS

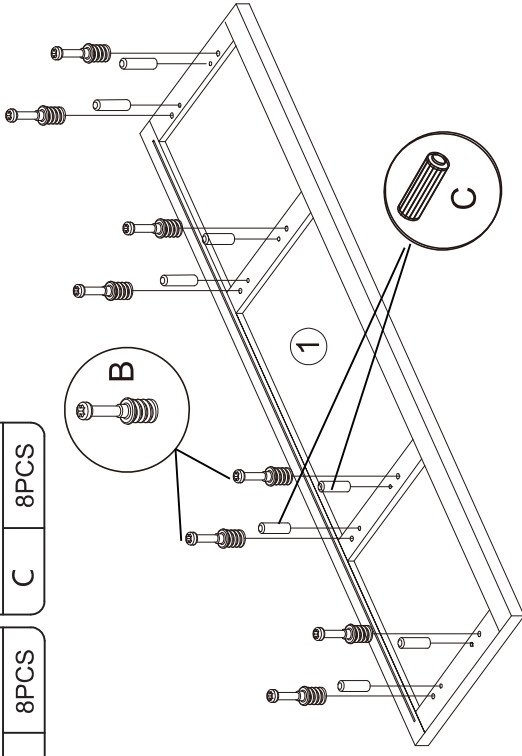

STEP 10

	Ø15 x 10mm	A	8PCS
--	------------	---	------

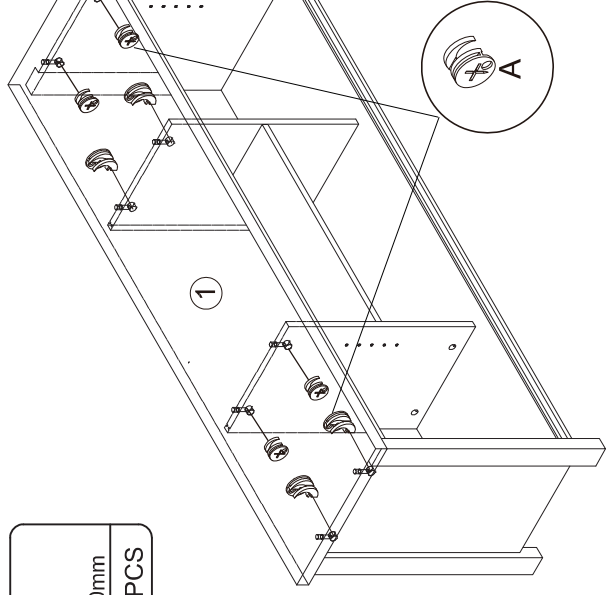

PRODUCT ASSEMBLY

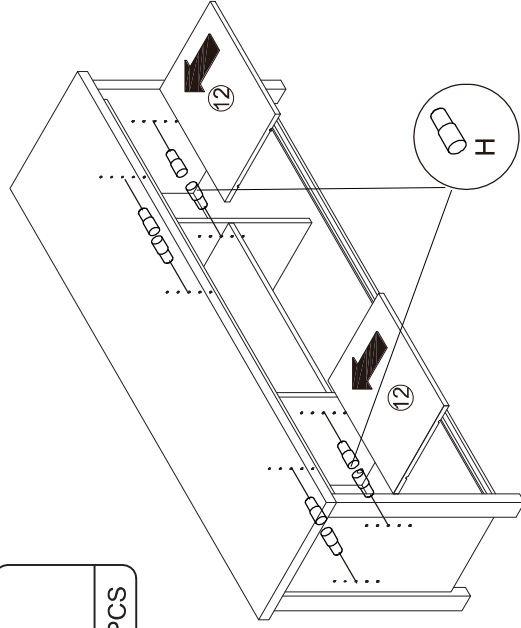

STEP 11

	H	8PCS
---	---	------





PRODUCT ASSEMBLY

STEP 13

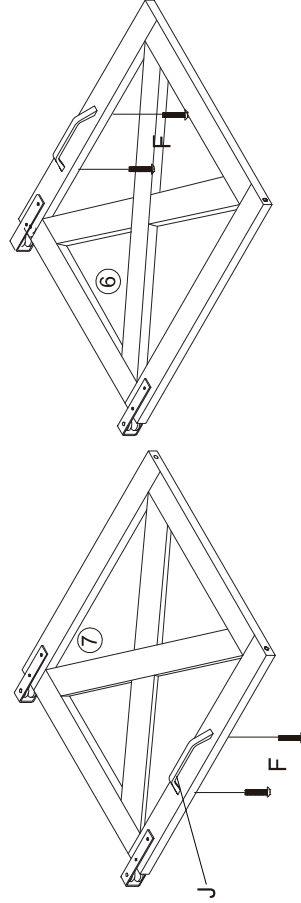
	M4 x 22mm	F	4PCS
	J	2PCS	



STEP 12

	Ø4.2 x 13mm	D	8PCS
	E	4PCS	
	I	4PCS	

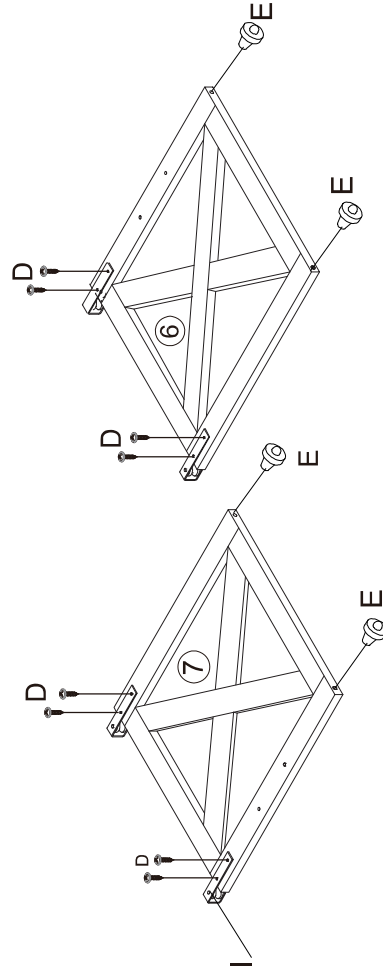

STEP 14

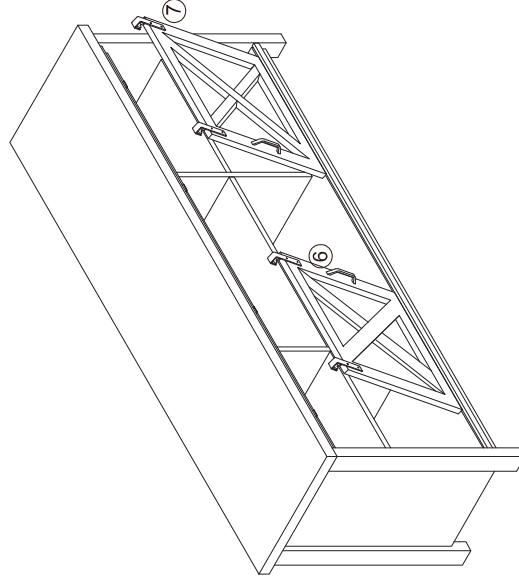

PRODUCT ASSEMBLY

STEP 15

	
Ø4.2 x 13mm	
D	2PCS

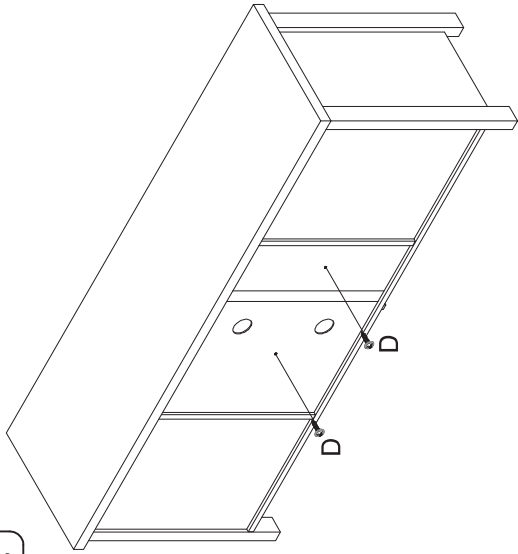

STEP 16

Maximum Loads

