

# User Manual

# JAXPETY

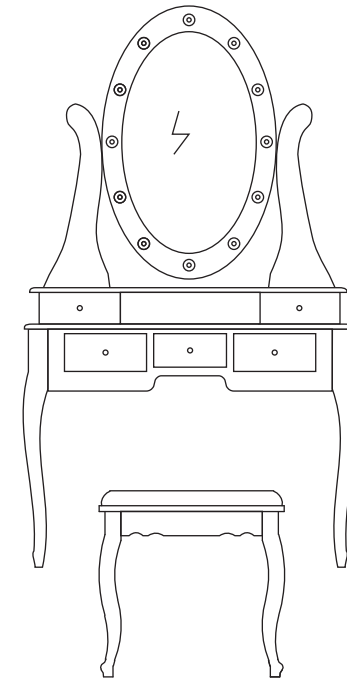

Model Number: HG61P0969



Scan ! To find more surprise!



## You need

**1 Tools required**

A Phillips head screwdriver is required for the assembly of this product. (not included)

Power tools should not be used to assemble this product.

**2 2 persons are needed**







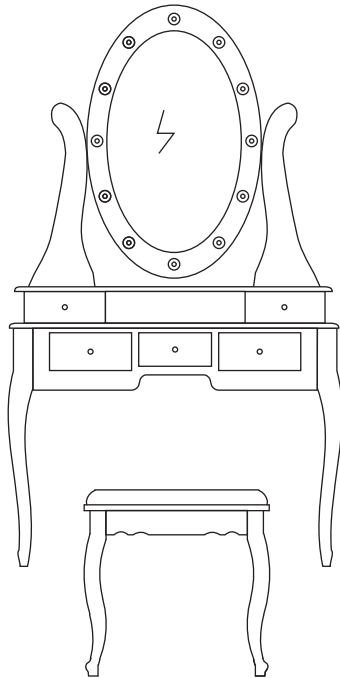

**3 Take 45 minutes**

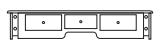
**45mins**

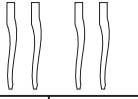
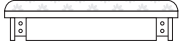
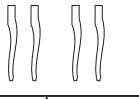
| Technical Specifications |         |
|--------------------------|---------|
| Brand                    | JAXPETY |



## Hardware List

|   |          |              |   |          |             |   |          |             |   |          |              |
|---|----------|--------------|---|----------|-------------|---|----------|-------------|---|----------|--------------|
|  | <b>A</b> | <b>1PC</b>   |  | <b>B</b> | <b>1PC</b>  |  | <b>C</b> | <b>2PCS</b> |  | <b>D</b> | <b>1PC</b>   |
|  | <b>E</b> | <b>4PCS</b>  |  | <b>F</b> | <b>1PC</b>  |  | <b>G</b> | <b>4PCS</b> |  | <b>1</b> | <b>16PCS</b> |
|  | <b>2</b> | <b>16PCS</b> |  | <b>3</b> | <b>6PCS</b> |  | <b>4</b> | <b>6PCS</b> |  | <b>5</b> | <b>2PCS</b>  |
|  | <b>6</b> | <b>1PC</b>   |   |          |             |   |          |             |   |          |              |

**PRODUCT ASSEMBLY**

**⚠** Check the package contents before getting started !

**STEP 1**

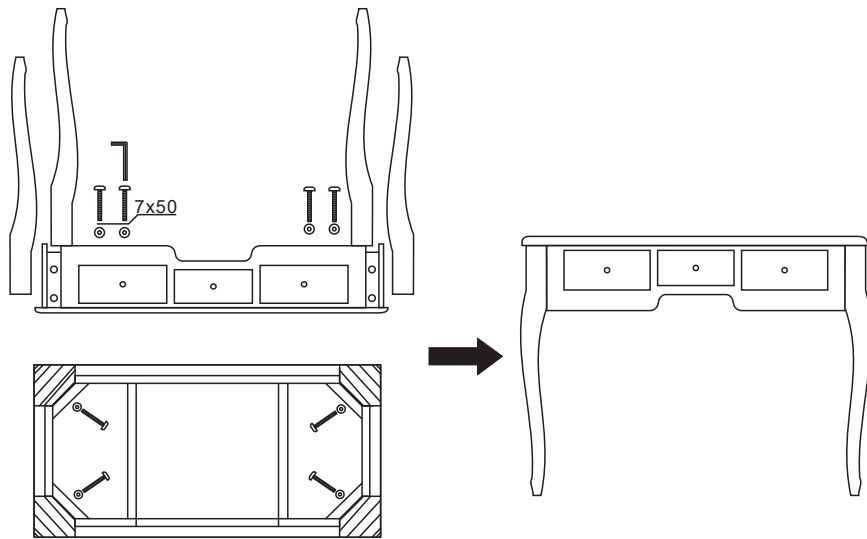
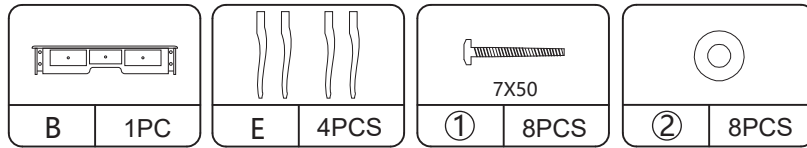

**PRODUCT ASSEMBLY**

**STEP 2**

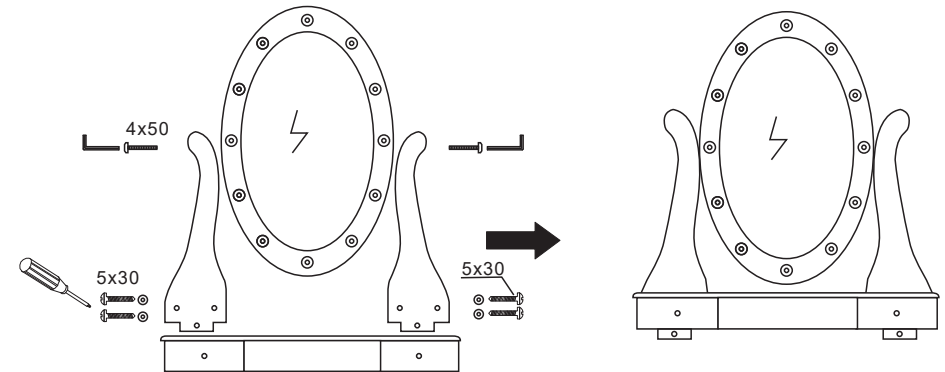
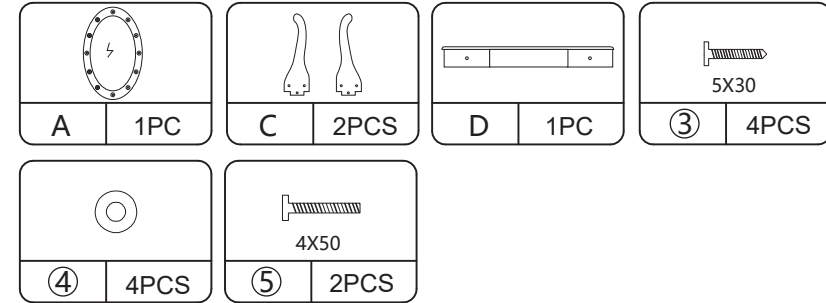

**PRODUCT ASSEMBLY**

**STEP 3**

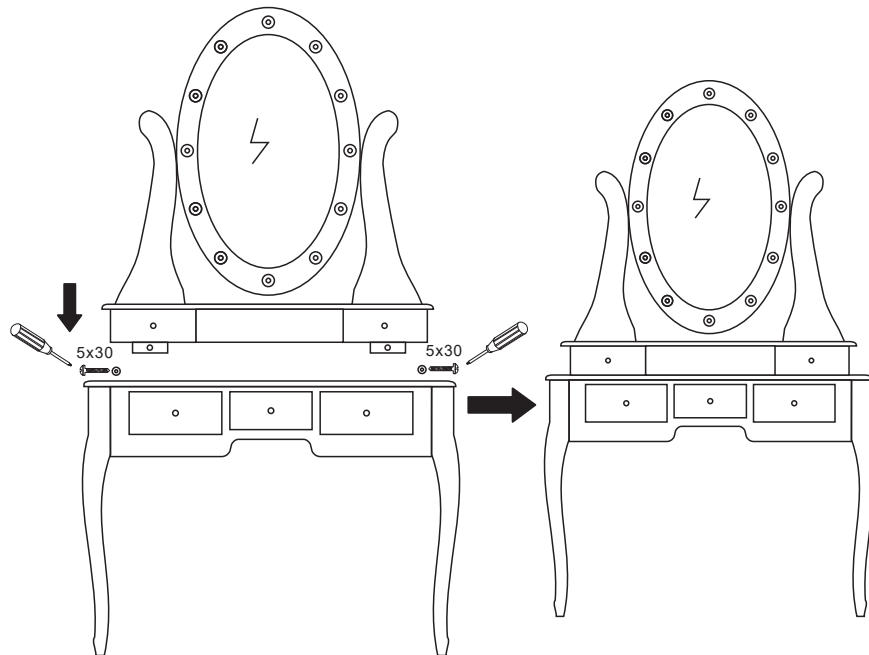
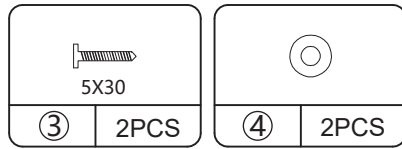

**PRODUCT ASSEMBLY**

**STEP 4**

