

User Manual

JAXPETY

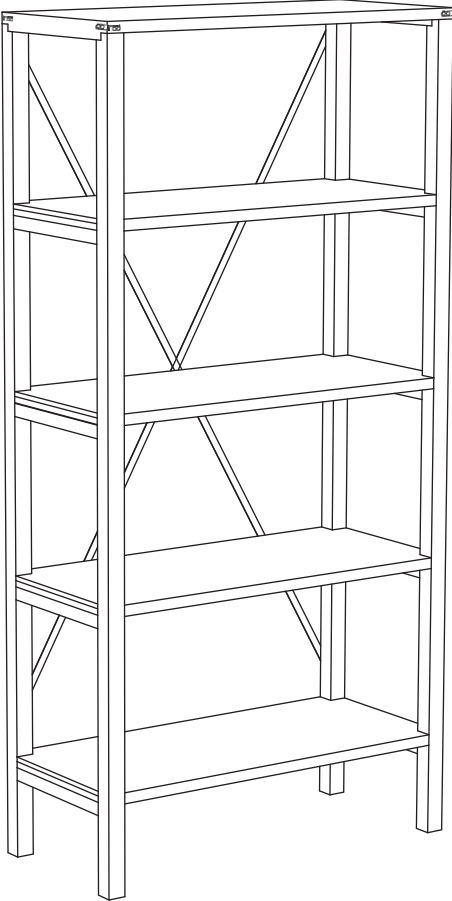





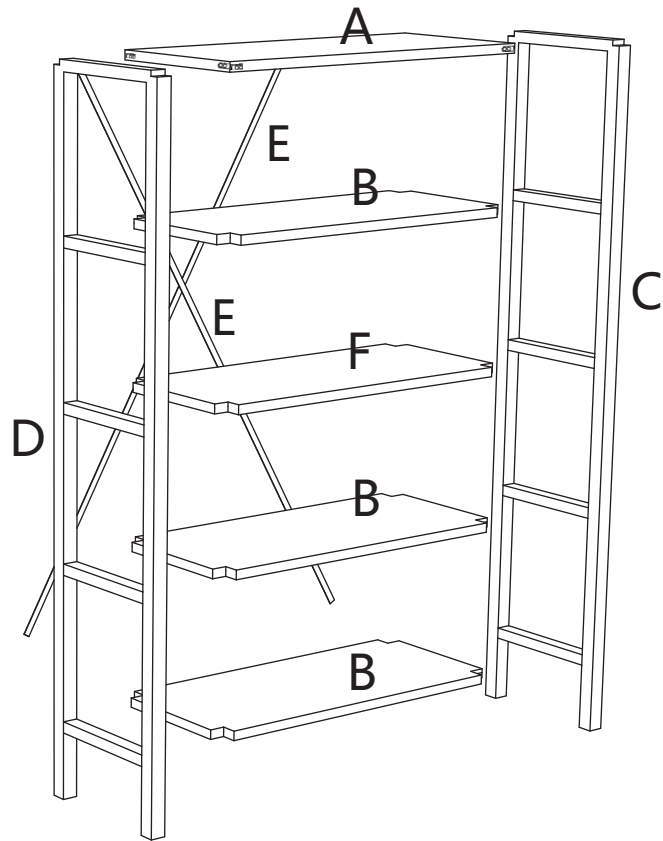
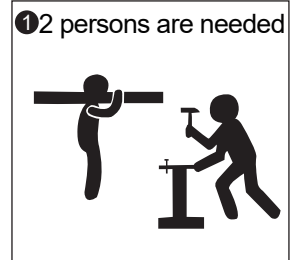





JAXPETY

You need



Hardware List

			
A 1PC	B 3PCS	C 1PC	D 1PC
		 M8*30	
E 2PCS	F 1PCS	① 20PCS	② 25PCS
 M8*20			
③ 5PCS	④ 2PCS	⑤ 1PC	

PRODUCT ASSEMBLY

 Check the package contents before getting started !

STEP 1

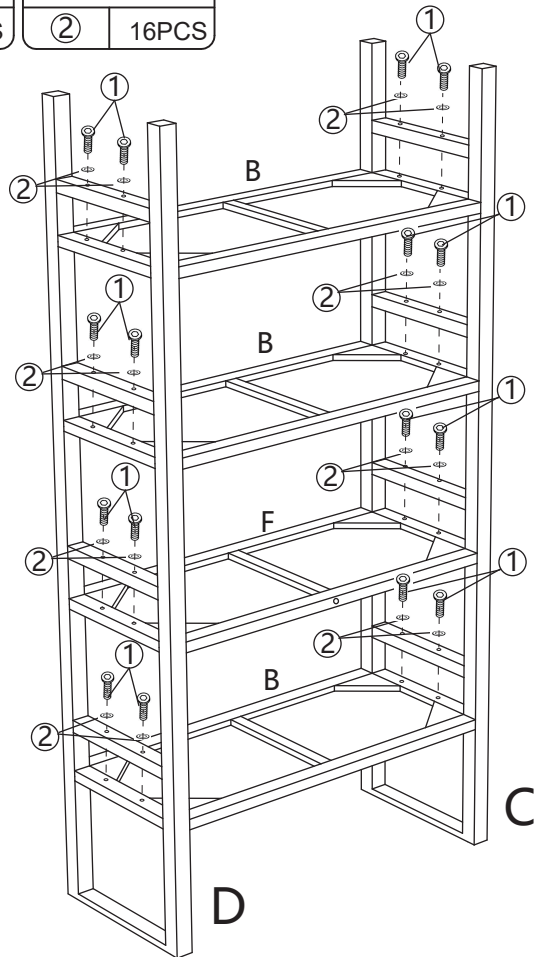
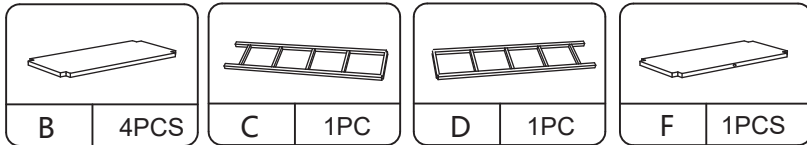

PRODUCT ASSEMBLY

STEP 2

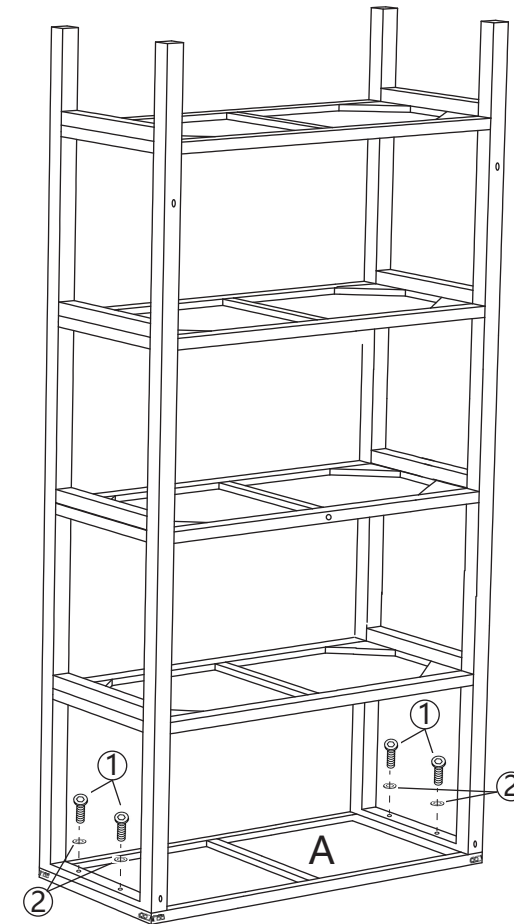
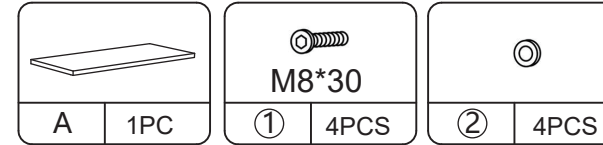

PRODUCT ASSEMBLY

STEP 3



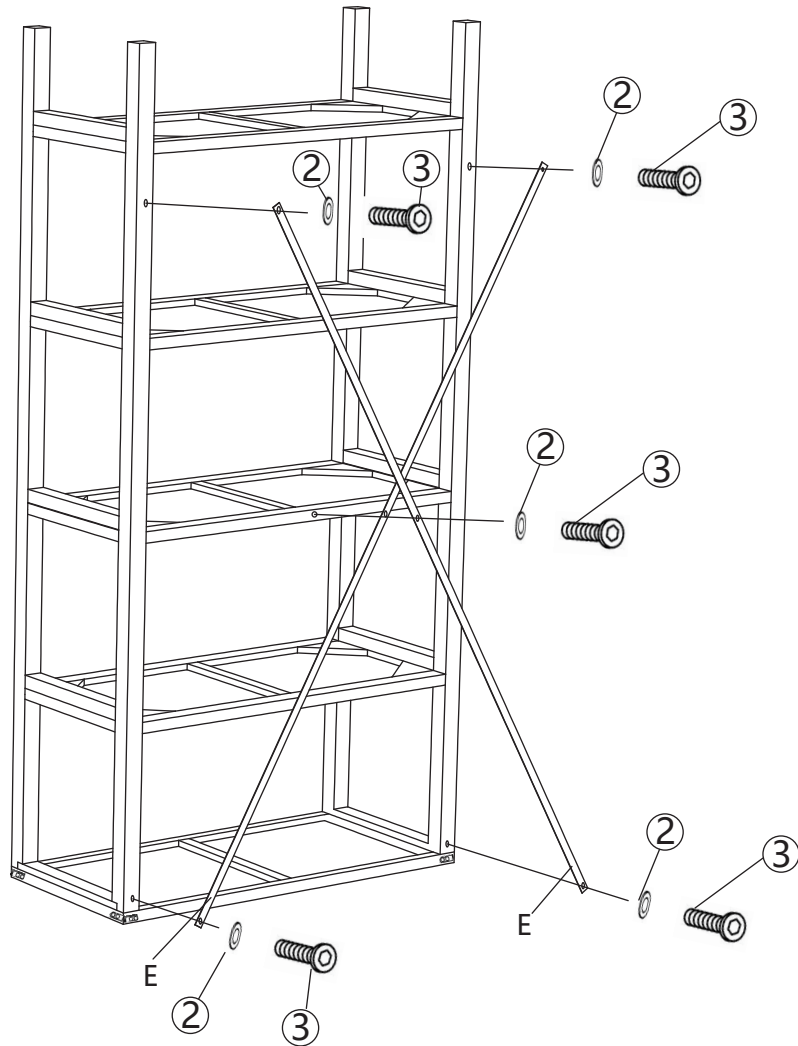

				 M8*20	
E	2PCS	②	5PCS	③	5PCS



PRODUCT ASSEMBLY

STEP 4

	
④	2PCS

PART LIST	FIGURE	QUANTITY
4.1		2PC
4.2		2PC
4.3		4PC
4.4		2PC
4.5		2PC

