

User Manual

JAXSUNNY

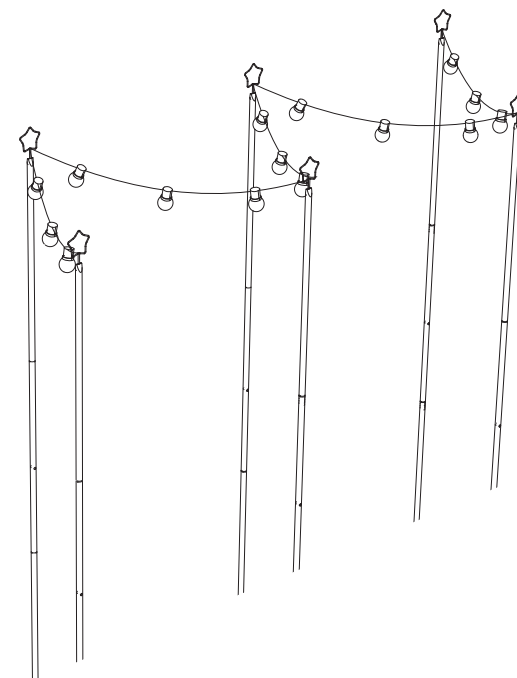

HG61U1207



HG61W1208



HG61X1209



HG61Y1210

The specific style shall prevail in kind

JAXSUNNY

PRODUCT ASSEMBLY

Dear Customer,

Thank you for your purchase.

JAXSUNNY is committed to providing affordable high-quality furniture worldwide.

Each piece is made with the respect for human and the environment.

Thousands of families use JAXSUNNY products as a home fashion.

When you receive the product, please make sure that all the parts are intact.

Then please browse the entire installation manual before assembly.

If problems occur unsatisfactorily as follows:

a.The outer box is damaged.

b.The product is damaged / bent / cracked while you open the box.

c.The parts / accessories / assembly tools are missing.

d.The product is hard to assemble.

e.The instructions are not clear and can not be referred to.

f.The product has functional problems.

g.Other aspects that you are not satisfied with.











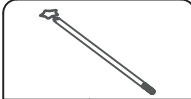

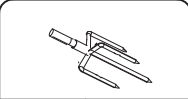
Please do not hesitate to contact us for help (Be sure to mark the **SKU NUMBER**, e.g., HG91S0320, and the **TRACKING NUMBER**).

Our JAXSUNNY team with factory direct after-sales service will reply within 24 hours and will do our best to resolve the problem for you. Our services are available at any time.

Sincerely,
JAXSUNNY Team





Hardware List

 A 6PCS	 B 6PCS	 C 6PCS	 D 6PCS
 E 6PCS	 M6*60 ① 6PCS	 M6 ② 6PCS	 ③ 6PCS
 ④ 24PCS	 ⑤ 36PCS	 ⑥ 6PCS	 ⑦ 6PCS
 M4*30 ⑧ 18PCS	 M4 ⑨ 18PCS		

PRODUCT ASSEMBLY

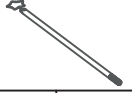
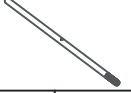
STEP 1

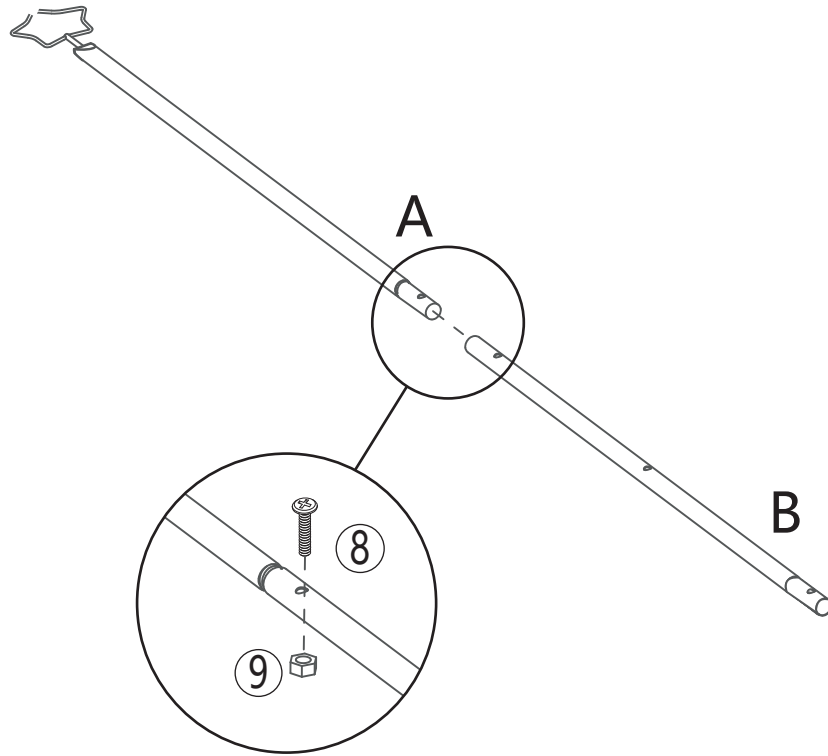

			
A	1PC	M4*30	M4
⑧	1PC	⑨	1PC



Screw the bolt into the small threaded hole to connect (A) with (B).

PRODUCT ASSEMBLY

STEP 2

		
C	M4*30	M4
1PC	⑧ 1PC	⑨ 1PC

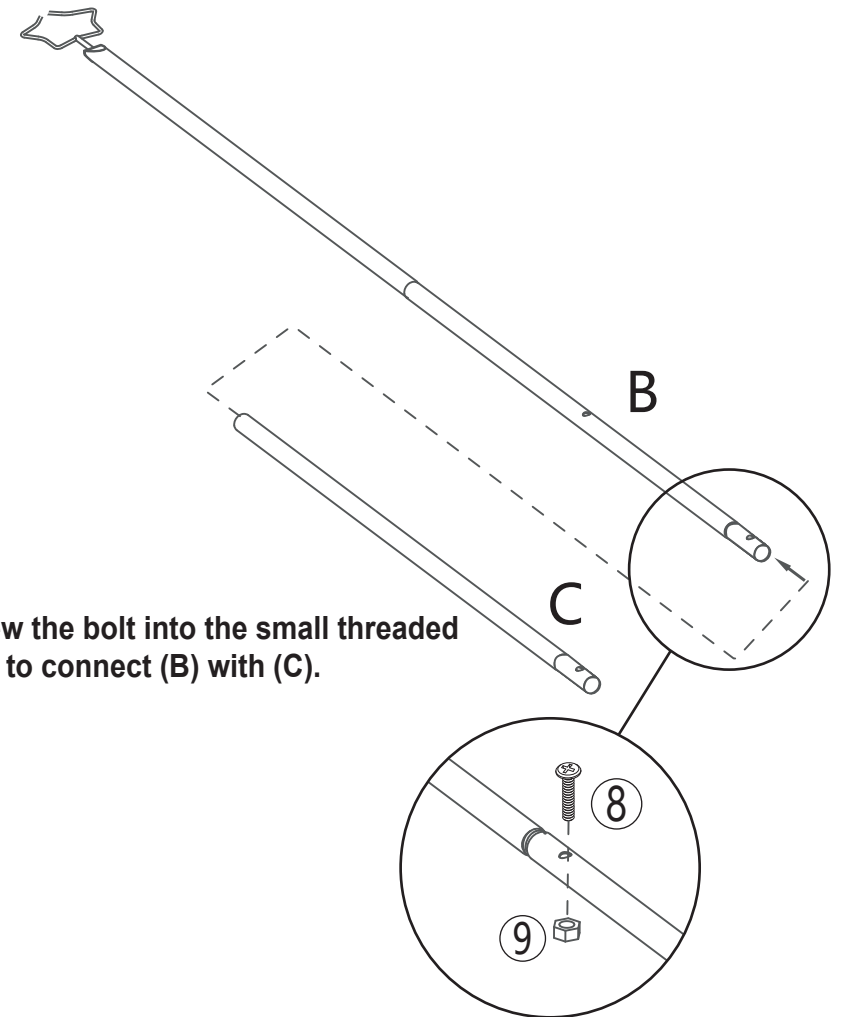

Screw the bolt into the small threaded hole to connect (B) with (C).

PRODUCT ASSEMBLY

STEP 3-1

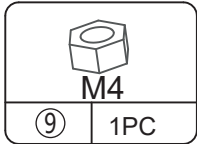
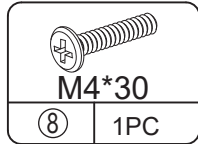
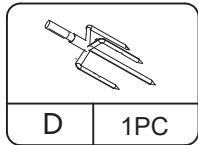

OR

STEP 3-2

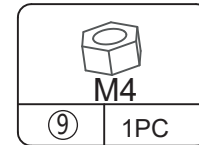
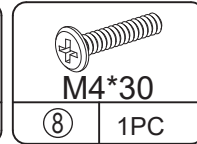
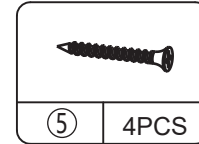
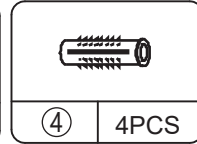
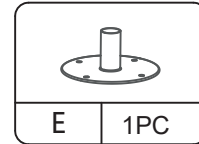

Choose bases as required.

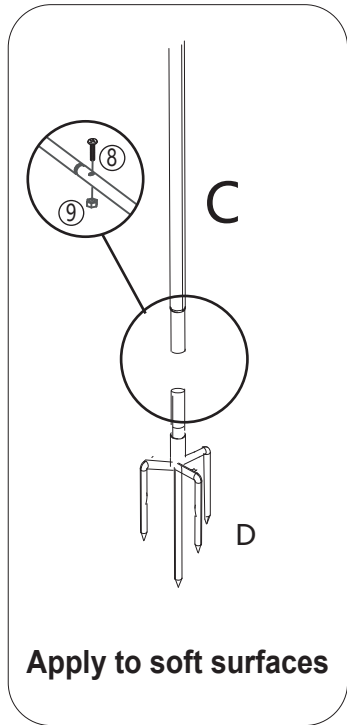

OR

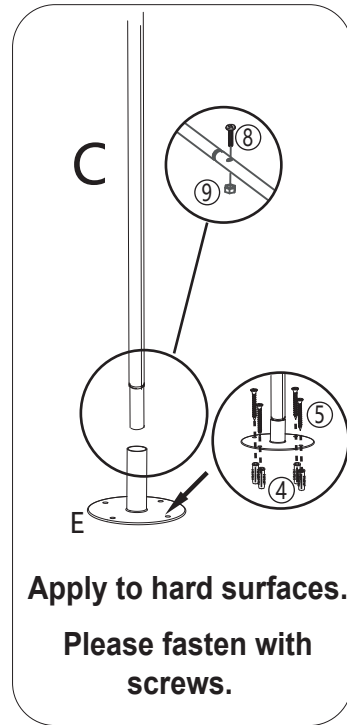

.Screw the bolt into the small threaded hole to secure (C) with the base (D or E).

PRODUCT ASSEMBLY

STEP 4

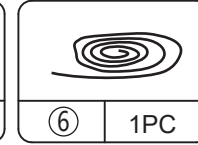
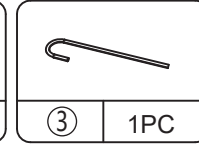
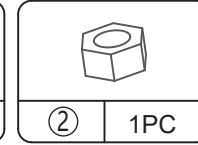

OR

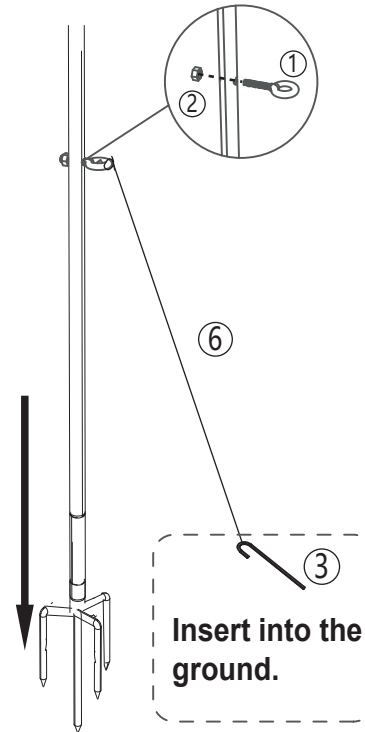
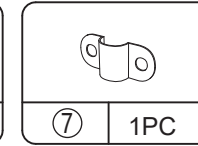
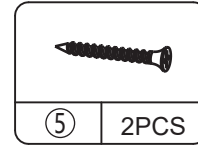

If the wind is too strong when used outdoors, you can perform Step 4 for reinforcement.

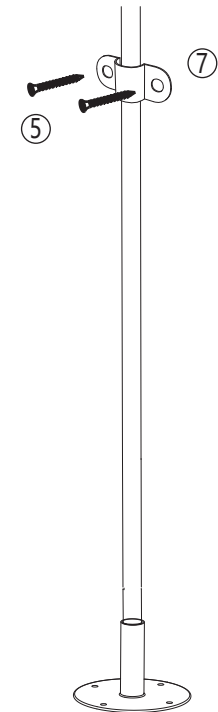

Screw the Q kits to secure the pole firmly.