

User Manual

Nyeekoy

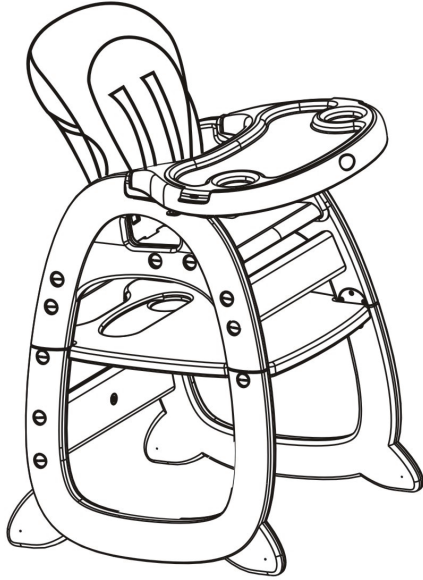

Model Number: TH17H0216
TH17K0217
TH17L0218

Nyeekoy

➔ **Instruction for Highchair**

Important-Retain for future reference,read carefully
 Suitable from 6 months to 6 years; less than 18kgs when
 the child could sit by himself.
 it could be used as table after 3 years old.

➔ **Major parts name:**

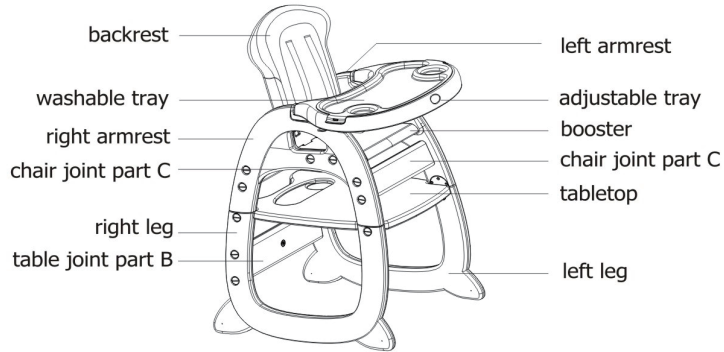

➔ **Installation instruction for Highchair**

Assemble the backrest and booster

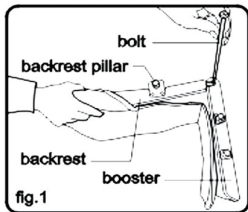

1.Button up the backrest and booster,
 put the bolt into the axle holes(fig.1)

Assemble the booster & backrest and the armrest

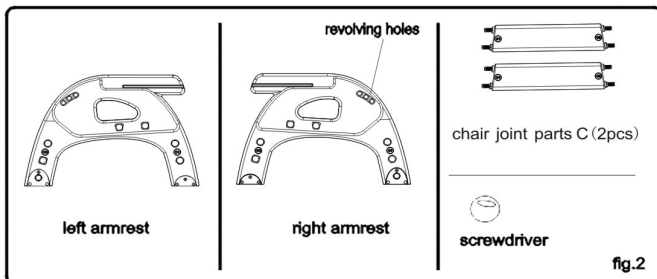

PRODUCT ASSEMBLY

Warning

1. Do not use until your child can sit by himself.
2. Do not use if any spare parts are broken, attrited or missed.
3. Do not use until all spare parts are rightly assembled and adjusted.
4. It is extremely dangerous place the high chair near the fire, heating appliance, such as electric welding and gas heater. Do not do it.
5. Prevent serious injury or death from falls or sliding out. Always secure the child in the restraint. Never leave child unattended.

PRODUCT ASSEMBLY

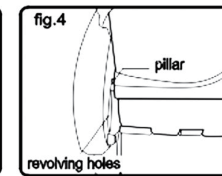
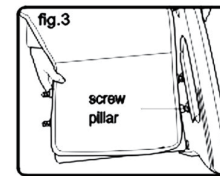

2. Put two screwed pillar on the base into the correlative hole on the left of chair armrest (fig.3)
3. Pillar on the backrest put into the correlative revolving holes(fig.4)

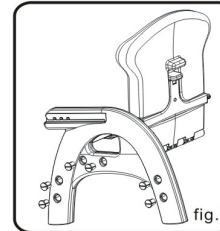

4. Using the screwdriver, insert the plastic screws into holes until locked (fig.5)

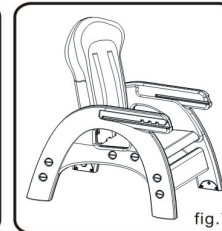
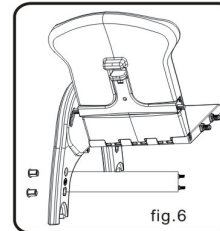

5. Insert two chair joint parts into the correlative holes.(fig.6) Then using the screw, fix up the joint parts, which the same as step 3 (fig.7)

Assemble the table

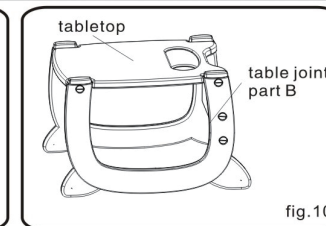
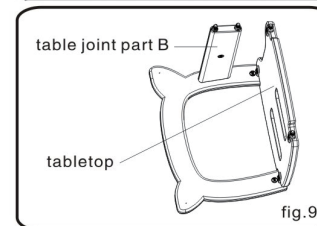
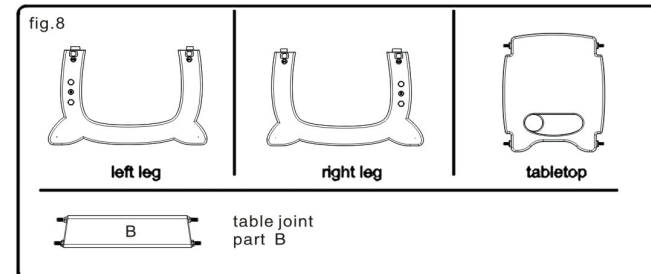

6. Insert tabletop, table joint part B into the correlative left or right holes(fig. 9&10) And tighten the screws and locked

PRODUCT ASSEMBLY

Assemble the chair and table

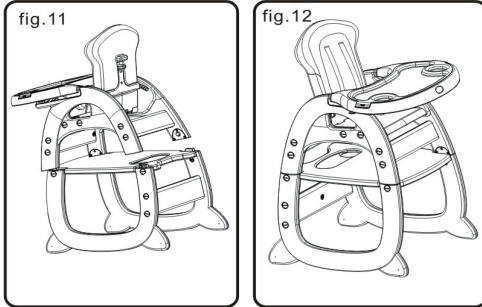

7. Assemble the front chairs match with table (fig.11) then press the button finished as(fig.12)

Install and adjust the adjustable tray

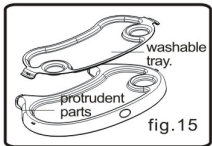
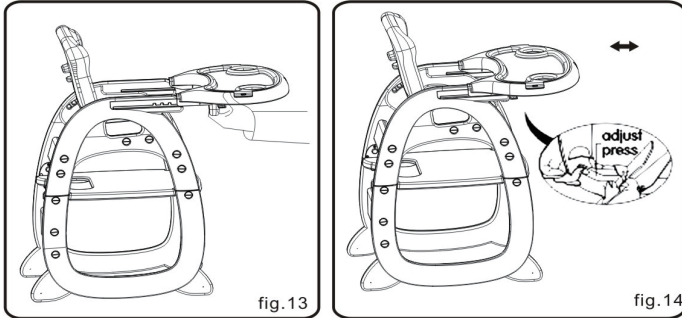

8. Inset notches on both side into the correlative place (fig.13); Press the adjustable button and meantime pull the tray out until heard the click (fig.14&15) The tray could be adjusted 3-positioned.

Adjust the backrest

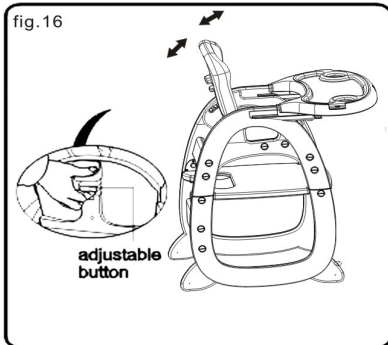

9. The backrest could be adjusted 3-positioned: Pull up the adjustable button and then to the desired position. (fig. 16)

PRODUCT ASSEMBLY

Remove and discharge the cover

- 10. Press the oval button on the middle of buckle, and open the buckle. (fig.17)
- 11. Press the button on the insert buckle side, and pull the belt out (fig.18)
- 12. Pull out the belt from the buttonhole, then discharge the cover. (fig.19-22)

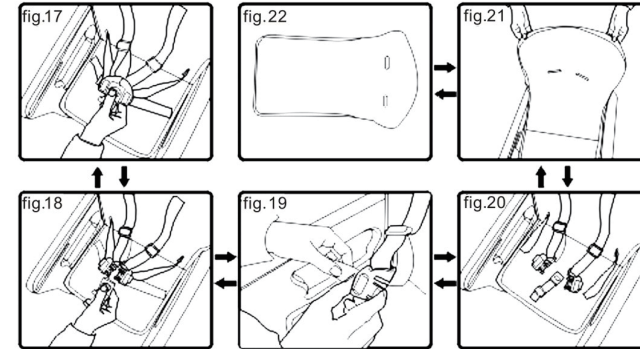

Install table leg cover

- 13. Please make sure there are four different cover as D1,D2,D3,D4. Install each cover into the correlative position (fig.23)

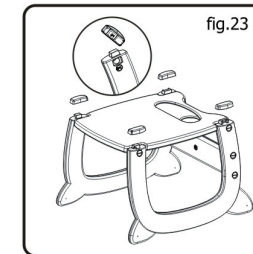

Status when using as table and chair

Highchair operating instructions

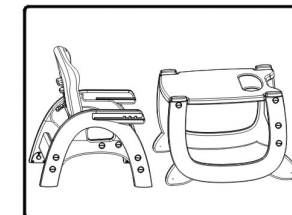

- Fitting your child into the chair
- 1. Sit your child into the chair after fixing.
 - 2. Fasten the buckle.
 - 3. Adjust the belt system to the desired length.
 - 4. Install the adjustable tray.